



Solving your relay requirements since 1922

Amperite Co.

(800) 752-2329  
www.Amperite.com

## B Series TDR

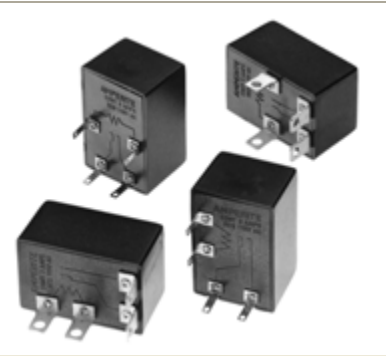

- ... Delay on Make or Delay on Break timing modes
- ... Thermal device
- ... 3 AMP rating
- ... Low cost
- ... 1 - 115V input voltage range - works on AC or DC
- ... Isolated output contacts
- ... Fixed delay times only
- ... Initial and reset (release) delay device
- ... Long life
- ... UL File #E96739 (M)
- ... CSA Rile #LR62586

### Timing Mode:

Timing cycle begins upon application of power to the heater terminals. At the end of the initial delay time the relay contacts transfer and remain in a transferred state until input power is removed. When the heater input power is removed, the contacts transfer back to their original state at the end of a reset (release) delay period.

### Timing Diagram:

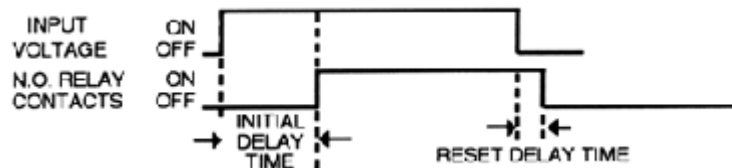

### Contact Information:

Arrangement:

1 form A (SPST - Normally open) - Delay on Make

1 form B (SPST - Normally closed) - Delay on Break

Contact Material: Silver - Cadmium Oxide

Rating (Resistive): 3A @ 115V AC

Expected Life @ 25° C: 500,000 operations minimum at rated loads

### Environmental Information:

Temperature Range: Operating & storage: -34° C to +77° C,  
(-30° F to +171° F)

### Mechanical Information:

Termination: .110 inch (standard), .250 inch or screw terminals (optional).

Enclosure: Black plastic case.

 <p><b>AMPERITE</b> Solving your relay requirements since 1922</p>	<p>Amperite Co.</p> <p>(800) 752-2329 www.Amperite.com</p>
---	--

Mounting: Single screw or optional 2-screw panel mount  
 Weight: 0.8 oz. (239g.) approx.

**Outline Dimensions:**

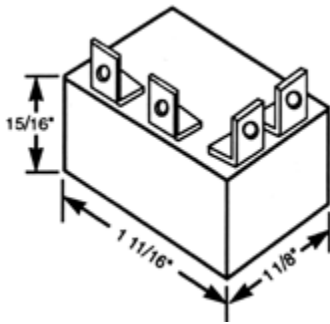

**Timing Specifications:**

Timing - Fixed: 2 through 300 secs.  
 Timing Tolerance:  $\pm 20\%$  - Tighter tolerances are available.  
 Repeatability:  $\pm 5\%$   
 Release Time - Fixed: Varies with initial delay - contact factory  
 Timing Cycle Interrupt Transfer: none

**Initial Dielectric Strength:**

Between open contacts: 500V RMS  
 Between contacts & Coil: 500V RMS

**Input Information:**

Voltage: AC or DC - 6V, 12V, 26V, 50V and 115V (Other voltages are available)  
 Power Requirement: 2.3 Watts  
 Transient Protection: impervious to transients  
 Polarity Protection: None required

**Input Voltages & Limits:**

Nominal	Minimum	Maximum
5V AC/DC	4V	8V
12V AC/DC	10V	14V
26V AC/DC	22V	30V
50V AC/DC	42V	58V



Solving your relay requirements since 1922

Amperite Co.

(800) 752-2329  
www.Amperite.com

115V AC/DC

90V

130V

### Wiring Diagrams:

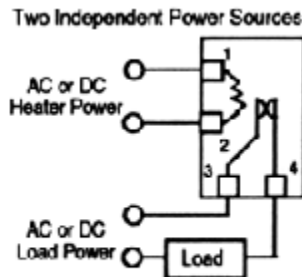

Diagram A

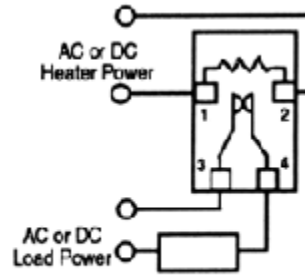

Diagram B

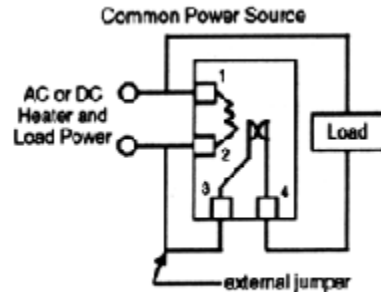

Diagram C



### Ordering Information:

Definition of a part for the Amperite B Series Time Delay Relay.

Example:

115 NO 60 X B  
 ↑    ↑    ↑    ↑    ↑  
 A    B    C    D    E

**A:** Denotes nominal input voltage. Voltages Available: 6, 12, 26, 50 & 115V AC/DC. Custom Voltages are available.

**B:** Denotes contact form:

NO = normally open (Delay on Make) - 1 form A - SPST

C = normally closed (Delay on Break) - 1 form B - SPST

**C:** Denotes timing value. Factory preset time delays from 2 - 300 secs. are available.

Note: Contact factory for release (reset) time.

**D:** Denotes form of termination:

Blank = .110 male electro-plate solder terminals (standard).

X = .250 male quick connect terminals (optional).

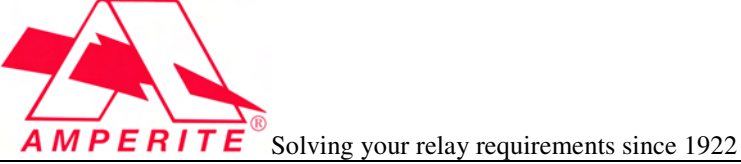
	Amperite Co.  (800) 752-2329 <a href="http://www.Amperite.com">www.Amperite.com</a>
---	--

S = screw terminals (optional).

**E:** Denotes use of thermal technology of B Series.

